

SMART REFERENCE LIST | SMART-ETHX PANEL CABIN 500 KW

SPECIAL STEEL STRUCTURE WITH KINGSPAN WALL PANELS, COVERING PLATES, GLASS ENTRY DOORS, MULTI-FUEL SILO DESIGN WITH WOOD CHIPS BLOWING PIPES DN150 AND ROOF FILLING OUTLETS, 4000 L OF ACCUMULATION TANK STORAGE, 1 HEATING CIRCUIT WITH COMPLETE REGULATION AND REMOTE Icloud VISUALISATION, CARNBOOTH HOUSE HOTEL HEATING, GLASGOW, SCOTLAND

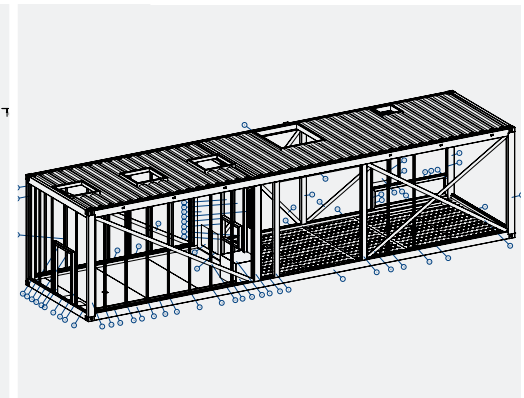
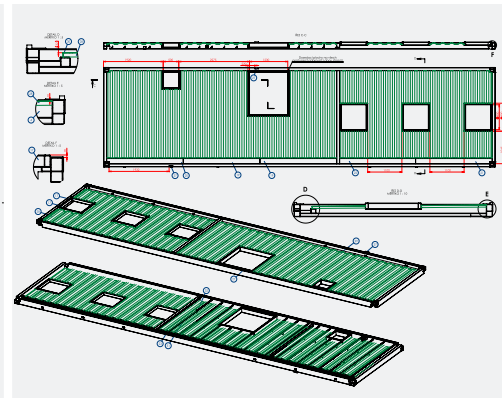
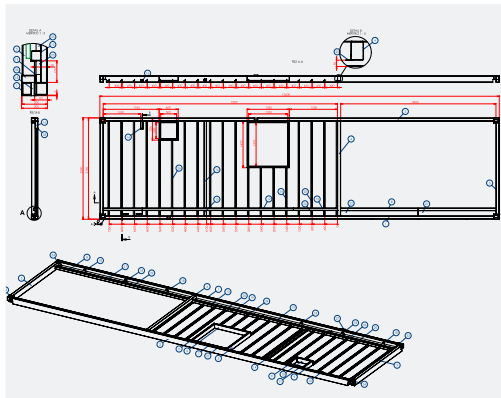
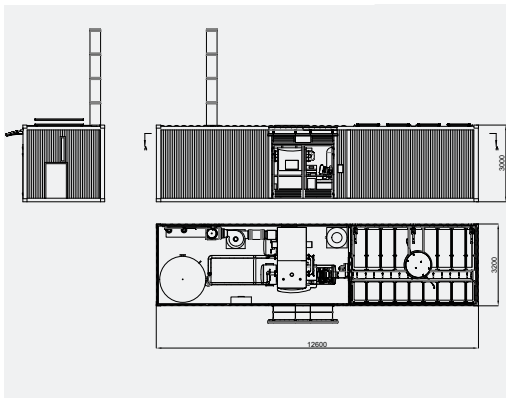
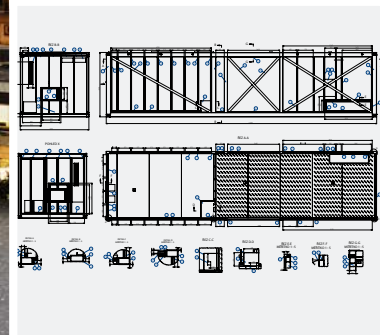
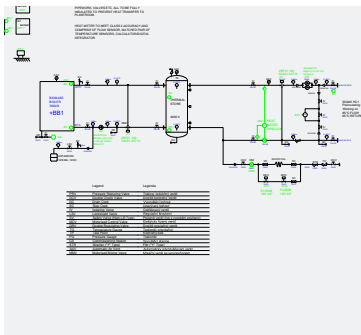
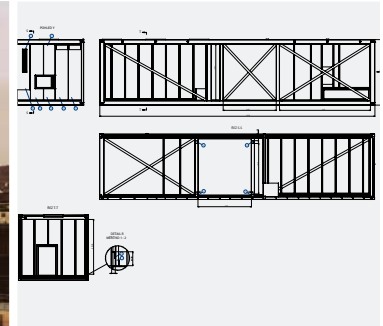
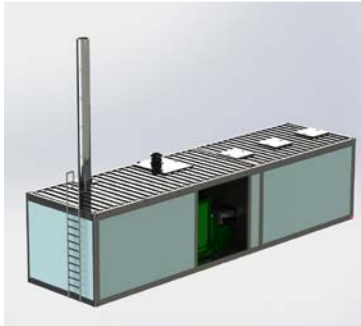

SMART REFERENCE LIST | SMART-ETHX PANEL CABIN 500 KW

SPECIAL STEEL STRUCTURE WITH KINGSPAN WALL PANELS, COVERING PLATES, GLASS ENTRY DOORS, MULTI-FUEL SILO DESIGN WITH WOOD CHIPS BLOWING PIPES DN150 AND ROOF FILLING OUTLETS, 4000 L OF ACCUMULATION TANK STORAGE, 1 HEATING CIRCUIT WITH COMPLETE REGULATION AND REMOTE Icloud VISUALISATION, CARNBOOTH HOUSE HOTEL HEATING, GLASGOW, SCOTLAND

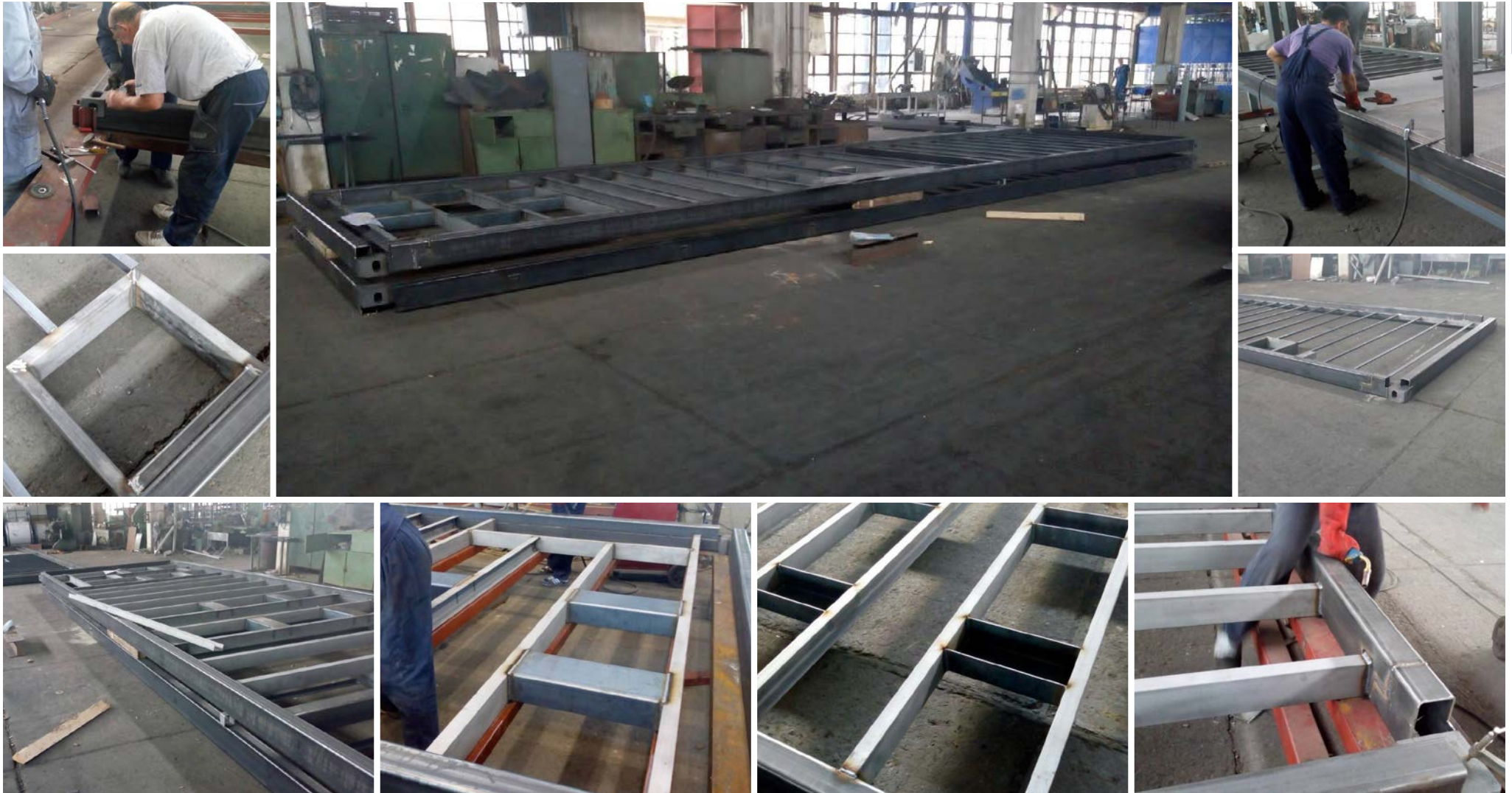

SMART REFERENCE LIST | SMART-ETHX PANEL CABIN 500 KW

SPECIAL STEEL STRUCTURE WITH KINGSPAN WALL PANELS, COVERING PLATES, GLASS ENTRY DOORS, MULTI-FUEL SILO DESIGN WITH WOOD CHIPS BLOWING PIPES DN150 AND ROOF FILLING OUTLETS, 4000 L OF ACCUMULATION TANK STORAGE, 1 HEATING CIRCUIT WITH COMPLETE REGULATION AND REMOTE Icloud VISUALISATION, CARNBOOTH HOUSE HOTEL HEATING, GLASGOW, SCOTLAND



SMART REFERENCE LIST | SMART-ETHX PANEL CABIN 500 KW

SPECIAL STEEL STRUCTURE WITH KINGSPAN WALL PANELS, COVERING PLATES, GLASS ENTRY DOORS, MULTI-FUEL SILO DESIGN WITH WOOD CHIPS BLOWING PIPES DN150 AND ROOF FILLING OUTLETS, 4000 L OF ACCUMULATION TANK STORAGE, 1 HEATING CIRCUIT WITH COMPLETE REGULATION AND REMOTE ICLLOUD VISUALISATION, CARNBOOTH HOUSE HOTEL HEATING, GLASGOW, SCOTLAND



SMART REFERENCE LIST | SMART-ETHX PANEL CABIN 500 KW

SPECIAL STEEL STRUCTURE WITH KINGSPAN WALL PANELS, COVERING PLATES, GLASS ENTRY DOORS, MULTI-FUEL SILO DESIGN WITH WOOD CHIPS BLOWING PIPES DN150 AND ROOF FILLING OUTLETS, 4000 L OF ACCUMULATION TANK STORAGE, 1 HEATING CIRCUIT WITH COMPLETE REGULATION AND REMOTE Icloud VISUALISATION, CARNBOOTH HOUSE HOTEL HEATING, GLASGOW, SCOTLAND



SMART REFERENCE LIST | SMART-ETHX PANEL CABIN 500 KW

SPECIAL STEEL STRUCTURE WITH KINGSPAN WALL PANELS, COVERING PLATES, GLASS ENTRY DOORS, MULTI-FUEL SILO DESIGN WITH WOOD CHIPS BLOWING PIPES DN150 AND ROOF FILLING OUTLETS, 4000 L OF ACCUMULATION TANK STORAGE, 1 HEATING CIRCUIT WITH COMPLETE REGULATION AND REMOTE ICLLOUD VISUALISATION, CARNBOOTH HOUSE HOTEL HEATING, GLASGOW, SCOTLAND





SMART HEATING TECHNOLOGY

SMART HEATING TECHNOLOGY

SMART REFERENCE LIST | SMART-ETHX PANEL CABIN 500 KW

SPECIAL STEEL STRUCTURE WITH KINGSPAN WALL PANELS, COVERING PLATES, GLASS ENTRY DOORS, MULTI-FUEL SILO DESIGN WITH WOOD CHIPS BLOWING PIPES DN150 AND ROOF FILLING OUTLETS, 4000 L OF ACCUMULATION TANK STORAGE, 1 HEATING CIRCUIT WITH COMPLETE REGULATION AND REMOTE Icloud VISUALISATION, CARNBOOTH HOUSE HOTEL HEATING, GLASGOW, SCOTLAND



SMART REFERENCE LIST | SMART-ETHX PANEL CABIN 500 KW

SPECIAL STEEL STRUCTURE WITH KINGSPAN WALL PANELS, COVERING PLATES, GLASS ENTRY DOORS, MULTI-FUEL SILO DESIGN WITH WOOD CHIPS BLOWING PIPES DN150 AND ROOF FILLING OUTLETS, 4000 L OF ACCUMULATION TANK STORAGE, 1 HEATING CIRCUIT WITH COMPLETE REGULATION AND REMOTE Icloud VISUALISATION, CARNBOOTH HOUSE HOTEL HEATING, GLASGOW, SCOTLAND



SMART REFERENCE LIST | SMART-ETHX PANEL CABIN 500 KW

SPECIAL STEEL STRUCTURE WITH KINGSPAN WALL PANELS, COVERING PLATES, GLASS ENTRY DOORS, MULTI-FUEL SILO DESIGN WITH WOOD CHIPS BLOWING PIPES DN150 AND ROOF FILLING OUTLETS, 4000 L OF ACCUMULATION TANK STORAGE, 1 HEATING CIRCUIT WITH COMPLETE REGULATION AND REMOTE Icloud VISUALISATION, CARNBOOTH HOUSE HOTEL HEATING, GLASGOW, SCOTLAND



SMART REFERENCE LIST | SMART-ETHX PANEL CABIN 500 KW

SPECIAL STEEL STRUCTURE WITH KINGSPAN WALL PANELS, COVERING PLATES, GLASS ENTRY DOORS, MULTI-FUEL SILO DESIGN WITH WOOD CHIPS BLOWING PIPES DN150 AND ROOF FILLING OUTLETS, 4000 L OF ACCUMULATION TANK STORAGE, 1 HEATING CIRCUIT WITH COMPLETE REGULATION AND REMOTE Icloud VISUALISATION, CARNBOOTH HOUSE HOTEL HEATING, GLASGOW, SCOTLAND



SMART REFERENCE LIST | SMART-ETHX PANEL CABIN 500 KW

SPECIAL STEEL STRUCTURE WITH KINGSPAN WALL PANELS, COVERING PLATES, GLASS ENTRY DOORS, MULTI-FUEL SILO DESIGN WITH WOOD CHIPS BLOWING PIPES DN150 AND ROOF FILLING OUTLETS, 4000 L OF ACCUMULATION TANK STORAGE, 1 HEATING CIRCUIT WITH COMPLETE REGULATION AND REMOTE Icloud VISUALISATION, CARNBOOTH HOUSE HOTEL HEATING, GLASGOW, SCOTLAND

